

**B-294
B-295
301-A
B-294 HD**

**NOTE: Order parts by Catalog Number only.
DO NOT order by Reference Number.**

Ref. No.	Catalog No.	Description
—	36642	B-294 Foot Switch
—	36647	B-295 Foot Switch
—	36662	301-A Foot Switch
—	75962	B-294 HD Foot Switch
1	36667	Warning Label (B-294)
	36672	Warning Label (B-295)
	36687	Warning Label (301-A)
	76352	Warning Label (B-294 HD)
2	36692	Cover
3	36787	Screw #10 Self-tapping (5)
4	36697	Foot Pedal
5	68880	Cord (B-294)
	36712	Cord (B-295)
	36727	Cord (301-A)
	75972	Cord (B-294 HD)
6	36732	Cord Connector
	75977	Cord Connector (B-294 HD)
7	36702	Spring
8	54347	Base
9	36747	Pivot Pin
10	36767	O-Ring
11	36772	Poppet
12	54367	Insulator
13	36762	Micro Switch
14	54372	Seal
15	54362	Bottom Cover
16	54357	Bottom Cover Screw (4)

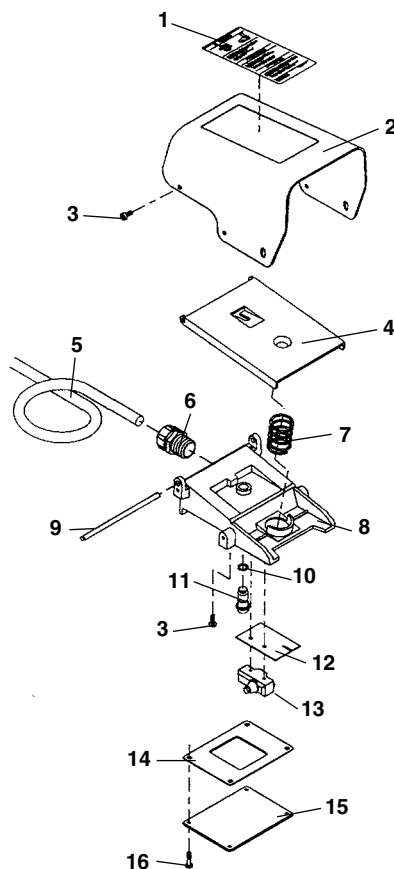

**B-296
B-297
B-298
B-299**

Ref. No.	Catalog No.	Description
—	36652	B-296 Foot Switch
—	36657	B-297 Foot Switch
—	40017	B-298 Foot Switch (U.K.)
—	40022	B-299 Foot Switch (Australia)
1	36677	Warning Label (B-296)
	36682	Warning Label (B-297)
	54392	Warning Label (B-298)
	45017	Warning Label (B-299)
2	54382	Cover
3	36787	Screw #10 Self-tapping (6)
4	36697	Foot Pedal
5	36717	Cord (B-299)
	18906	Cord (B-296)
	36722	Cord (B-297)
	45027	Cord (B-298)
6	36732	Cord Connector (2)
7	36702	Spring
8	54352	Base
9	18916	Line Cord (B-296)
	36797	Line Cord (B-297)
	45022	Line Cord (B-298)
	93210	Line Cord (B-299)
10	36747	Pivot Pin
11	36767	O-Ring
12	36772	Poppet
13	54367	Insulator (2)
14	36762	Micro Switch (2)
15	54377	Switch Bracket
16	54372	Seal
17	54362	Bottom Cover
18	54357	Bottom Cover Screw (4)

